

DESA™

HEATING PRODUCTS

UNVENTED (VENT-FREE) GAS STOVE HEATER OWNER'S OPERATION AND INSTALLATION MANUAL



Patent Pending

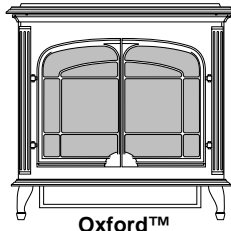

Oxford™

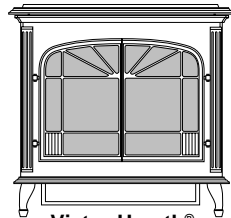

Victor Hearth®



MODEL SVYD18NRA/PRA SERIES REMOTE-READY CONTROL GAS LOG HEATER (BURNER SYSTEM FOR CAST IRON STOVES)

WARNING: If the information in this manual is not followed exactly, a fire or explosion may result causing property damage, personal injury, or loss of life.

- Do not store or use gasoline or other flammable vapors and liquids in the vicinity of this or any other appliance.
- **WHAT TO DO IF YOU SMELL GAS**
 - Do not try to light any appliance.
 - Do not touch any electrical switch; do not use any phone in your building.
 - Immediately call your gas supplier from a neighbor's phone. Follow the gas supplier's instructions.
 - If you cannot reach your gas supplier, call the fire department.
- Installation and service must be performed by a qualified installer, service agency, or the gas supplier.

WARNING: The SVYD18NRA/PRA series vent-free gas log heater is only approved for use in the VCIS(*) series, PVCIS(*) series, or VH(*)A series cast iron stove models.

(* Indicates Color Suffix Designation)

WARNING: Improper installation, adjustment, alteration, service, or maintenance can cause injury or property damage. Refer to this manual for correct installation and operational procedures. For assistance or additional information consult a qualified installer, service agency, or the gas supplier.

WARNING: This is an unvented gas-fired heater. It uses air (oxygen) from the room in which it is installed. Provisions for adequate combustion and ventilation air must be provided. Refer to *Air for Combustion and Ventilation* section on page 5 of this manual.

This appliance may be installed in an aftermarket,* permanently located, manufactured (mobile) home, where not prohibited by local codes.

This appliance is only for use with the type of gas indicated on the rating plate. This appliance is not convertible for use with other gases.

* Aftermarket: Completion of sale, not for purpose of resale, from the manufacturer

TABLE OF CONTENTS

Safety Information	3	Troubleshooting	19
Product Identification	4	Illustrated Parts Breakdown and Parts List	22
Local Codes	5	Specifications	26
Product Features	5	Replacement Parts	26
Air For Combustion And Ventilation	5	Wiring Diagram	26
Installation	8	Service Hints	26
Operating Heater	14	Technical Service	26
Inspecting Burners	17	Accessories	27
Cleaning and Maintenance	18	Warranty Information	Back Cover

SAFETY INFORMATION

⚠ WARNING: This product contains and/or generates chemicals known to the state of California to cause cancer or birth defects, or other reproductive harm.

IMPORTANT: Read this owner's manual carefully and completely before trying to assemble, operate, or service this heater. Improper use of this heater can cause serious injury or death from burns, fire, explosion, electrical shock, and carbon monoxide poisoning.

⚠ DANGER: Carbon monoxide poisoning may lead to death!

Carbon Monoxide Poisoning: Early signs of carbon monoxide poisoning resemble the flu, with headaches, dizziness, or nausea. If you have these signs, the heater may not be working properly. **Get fresh air at once!** Have heater serviced. Some people are more affected by carbon monoxide than others. These include pregnant women, people with heart or lung disease or anemia, those under the influence of alcohol, and those at high altitudes.

Natural and Propane/LP Gas: Natural and propane/LP gases are odorless. An odor-making agent is added to the gas. The odor helps you detect a gas leak. However, the odor added to the gas can fade. Gas may be present even though no odor exists.

Make certain you read and understand all warnings. Keep this manual for reference. It is your guide to safe and proper operation of this heater.

⚠ WARNING: Any change to this heater or its controls can be dangerous.

⚠ WARNING: Do not allow fans to blow directly into the heater. Avoid any drafts that alter burner flame patterns. Ceiling fans can create drafts that alter burner flame patterns. Altered burner patterns can cause sooting.

⚠ WARNING: Do not use a blower insert, heat exchanger insert, or other accessory not approved for use with this heater.

Due to high temperatures, the appliance should be located out of traffic and away from furniture and draperies.

Do not place clothing or other flammable material on or near the appliance. Never place any objects on the heater.

Stove becomes very hot when running heater. Keep children and adults away from hot surface to avoid burns or clothing ignition. Heater will remain hot for a time after shutdown. Allow surface to cool before touching.

Carefully supervise young children when they are in the room with stove. When using the optional hand-held remote accessory, keep selector switch in the OFF position to prevent children from turning on burners with remote.

Keep the appliance area clear and free from combustible materials, gasoline, and other flammable vapors and liquids.

1. This appliance is only for use with the type of gas indicated on the rating plate. This appliance is not convertible for use with other gases.
2. Do not place propane/LP supply tank(s) inside any structure. Locate propane/LP supply tank(s) outdoors (propane/LP units only).

SAFETY INFORMATION

Continued

3. If you smell gas
 - shut off gas supply
 - do not try to light any appliance
 - do not touch any electrical switch; do not use any phone in your building
 - immediately call your gas supplier from a neighbor's phone. Follow the gas supplier's instructions
 - if you cannot reach your gas supplier, call the fire department
4. This heater shall not be installed in a bedroom or bathroom.
5. Do not use this stove as a wood burning fireplace. Use only model SVYD18PRA/NRA series vent-free gas log heater for VCIS(*), PVCIS(*), and VH(*)A series cast iron stove models.
6. Do not add extra logs or ornaments such as pine cones, vermiculite, or rock wool. Using these added items can cause sooting.
7. This log heater is designed to be smokeless. If logs ever appear to smoke, turn off heater and call a qualified service person. *Note:* During initial operation, slight smoking could occur due to log curing and heater burning manufacturing residues.
8. To prevent the creation of soot, follow the instructions in *Cleaning and Maintenance*, page 18.
9. Before using furniture polish, wax, carpet cleaners, or similar products, turn heater off. If heated, the vapors from these products may create a white powder residue within burner box or on adjacent walls or furniture.
10. This heater needs fresh, outside air ventilation to run properly. This heater has an Oxygen Depletion Sensing (ODS) safety shutoff system. The ODS shuts down the heater if not enough fresh air is available. See *Air for Combustion and Ventilation*, pages 5 through 7. If heater keeps shutting off, see *Troubleshooting*, pages 19 through 21.
11. Do not run heater
 - where flammable liquids or vapors are used or stored
 - under dusty conditions
12. Do not use this stove to cook food or burn paper or other objects.
13. Do not use heater if any part has been exposed to or under water. Immediately call a qualified service technician to inspect the room heater and to replace any part of the control system and any gas control which has been under water.
14. Do not operate heater if any log is broken. Do not operate heater if a log is chipped (dime-sized or larger).
15. Turn heater off and let cool before servicing. Only a qualified service person should service and repair heater.
16. Operating heater above elevations of 4,500 feet could cause pilot outage.
17. To prevent performance problems, the use of a propane/LP tank of less than 100 lb. capacity (propane/LP units only).
18. Provide adequate clearances around air openings.

PRODUCT IDENTIFICATION

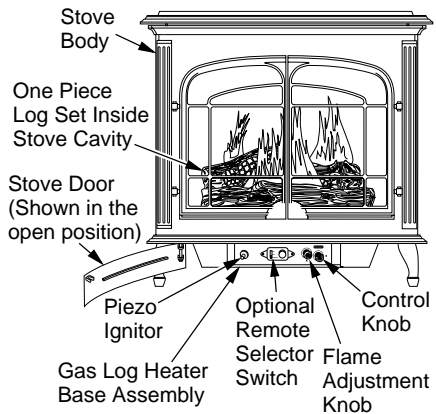

Figure 1 - Typical Stove Cabinet Model with Gas Log Heater (Shown is Oxford™ Model with Model SVYD18PRA/NRA Heater)

LOCAL CODES

Install and use heater with care. Follow all local codes. In the absence of local codes, use the latest edition of *The National Fuel Gas Code, ANSI Z223.1/NFPA 54**.

*Available from:

American National Standards Institute, Inc.
1430 Broadway
New York, NY 10018
National Fire Protection Association, Inc.
Batterymarch Park
Quincy, MA 02269

PRODUCT FEATURES

OPERATION

This heater is clean burning. It requires no outside venting. There is no heat loss out a vent or up a chimney. Heat is generated by realistic, dancing yellow flames. This heater is designed for vent-free operation. State and local codes in some areas prohibit the use of vent-free heaters.

SAFETY PILOT

This heater has a pilot with an Oxygen Depletion Sensing (ODS) safety shutoff system. The ODS/pilot is a required feature for vent-free room heaters. The ODS/pilot shuts off the heater if there is not enough fresh air.

PIEZO IGNITION SYSTEM

This heater has a piezo ignitor. This system requires no matches, batteries, or other sources to light heater.

AIR FOR COMBUSTION AND VENTILATION

 **WARNING: This heater shall not be installed in a confined space or unusually tight construction unless provisions are provided for adequate combustion and ventilation air. Read the following instructions to insure proper fresh air for this and other fuel-burning appliances in your home.**

Today's homes are built more energy efficient than ever. New materials, increased insulation, and new construction methods help reduce heat loss in homes. Home owners weather strip and caulk around windows and doors to keep the cold air out and the warm air in. During heating months, home owners want their homes as airtight as possible.

While it is good to make your home energy efficient, your home needs to breathe. Fresh air must enter your home. All fuel-burning appliances need fresh air for proper combustion and ventilation.

Exhaust fans, fireplaces, clothes dryers, and fuel burning appliances draw air from the house to operate. You must provide adequate fresh air for these appliances. This will insure proper venting of vented fuel-burning appliances.

PROVIDING ADEQUATE VENTILATION

The following are excerpts from *National Fuel Gas Code, ANSI Z223.1/NFPA 54, Section 5.3, Air for Combustion and Ventilation*.

All spaces in homes fall into one of the three following ventilation classifications:

1. Unusually Tight Construction
2. Unconfined Space
3. Confined Space

The information on pages 5 through 7 will help you classify your space and provide adequate ventilation.

AIR FOR COMBUSTION AND VENTILATION

Continued

Unusually Tight Construction

The air that leaks around doors and windows may provide enough fresh air for combustion and ventilation. However, in buildings of unusually tight construction, you must provide additional fresh air.

Unusually tight construction is defined as construction where:

- walls and ceilings exposed to the outside atmosphere have a continuous water vapor retarder with a rating of one perm (6×10^{-11} kg per pa-sec- m^2) or less with openings gasketed or sealed and
- weather stripping has been added on openable windows and doors and
- caulking or sealants are applied to areas such as joints around window and door frames, between sole plates and floors, between wall-ceiling joints, between wall panels, at penetrations for plumbing, electrical, and gas lines, and at other openings.

If your home meets all of these three criteria, you must provide additional fresh air. See *Ventilation Air From Outdoors*, page 7.

If your home does not meet all of the three criteria above, proceed to *Determining Fresh-Air Flow For Fireplace Location*, column 2.

Confined and Unconfined Space

The *National Fuel Gas Code, ANSI Z223.1/NFPA 54* defines a confined space as a space whose volume is less than 50 cubic feet per 1,000 Btu per hour (4.8 m^3 per kw) of the aggregate input rating of all appliances installed in that space and an unconfined space as a space whose volume is not less than 50 cubic feet per 1,000 Btu per hour (4.8 m^3 per kw) of the aggregate input rating of all appliances installed in that space. Rooms communicating directly with the space in which the appliances are installed*, through openings not furnished with doors, are considered a part of the unconfined space.

* Adjoining rooms are communicating only if there are doorless passageways or ventilation grills between them.

DETERMINING FRESH-AIR FLOW FOR HEATER LOCATION

Determining if You Have a Confined or Unconfined Space

Use this work sheet to determine if you have a confined or unconfined space.

Space: Includes the room in which you will install fireplace plus any adjoining rooms with doorless passageways or ventilation grills between the rooms.

- Determine the volume of the space (length x width x height).

Length x Width x Height = _____ cu. ft. (volume of space)

Example: Space size 20 ft. (length) x 16 ft. (width) x 8 ft. (ceiling height) = 2560 cu. ft. (volume of space)

If additional ventilation to adjoining room is supplied with grills or openings, add the volume of these rooms to the total volume of the space.

- Multiply the space volume by 20 to determine the maximum Btu/Hr the space can support.

_____ (volume of space) x 20 = (Maximum Btu/Hr the space can support)

Example: 2560 cu. ft. (volume of space) x 20 = 51,200 (maximum Btu/Hr the space can support)

- Add the Btu/Hr of all fuel burning appliances in the space.

Vent-free fireplace	_____	Btu/Hr
Gas water heater*	_____	Btu/Hr
Gas furnace	_____	Btu/Hr
Vented gas heater	_____	Btu/Hr
Gas fireplace logs	_____	Btu/Hr
Other gas appliances* +	_____	Btu/Hr
Total	= _____	Btu/Hr

* Do not include direct-vent gas appliances. Direct-vent draws combustion air from the outdoors and vents to the outdoors.

Example:

Gas water heater	_____	40,000	Btu/Hr
Vent-free fireplace	+ _____	30,000	Btu/Hr
Total	= _____	70,000	Btu/Hr

- Compare the maximum Btu/Hr the space can support with the actual amount of Btu/Hr used.

_____ Btu/Hr (maximum the space can support)

_____ Btu/Hr (actual amount of Btu/Hr used)

Example: 51,200 Btu/Hr (maximum the space can support)

70,000 Btu/Hr (actual amount of Btu/Hr used)

The space in the above example is a confined space because the actual Btu/Hr used is more than the maximum Btu/Hr the space can support. You must provide additional fresh air. Your options are as follows:

AIR FOR COMBUSTION AND VENTILATION

Continued

- Rework worksheet, adding the space of an adjoining room. If the extra space provides an unconfined space, remove door to adjoining room or add ventilation grills between rooms. See *Ventilation Air From Inside Building*.
- Vent room directly to the outdoors. See *Ventilation Air From Outdoors*.
- Install a lower Btu/Hr fireplace, if lower Btu/Hr size makes room unconfined.

If the actual Btu/Hr used is less than the maximum Btu/Hr the space can support, the space is an unconfined space. You will need no additional fresh air ventilation.

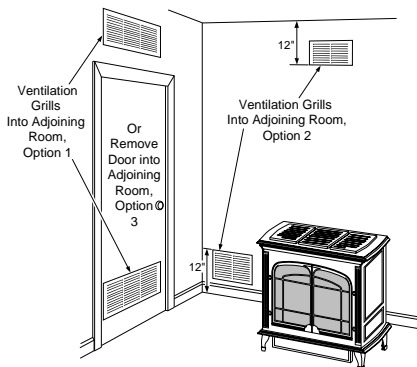

Figure 2 - Ventilation Air from Inside Building (Oxford™ Stove Model Shown)

⚠ WARNING: If the area in which the heater may be operated is smaller than that defined as an unconfined space or if the building is of unusually tight construction, provide adequate combustion and ventilation air by one of the methods described in the *National Fuel Gas Code, ANSI Z223.1/NFPA 54 Section 5.3* or applicable local codes.

Ventilation Air From Outdoors

Provide extra fresh air by using ventilation grills or ducts. You must provide two permanent openings: one within 12" of the ceiling and one within 12" of the floor. Connect these items directly to the outdoors or spaces open to the outdoors. These spaces include attics and crawl spaces. Follow the *National Fuel Gas Code, ANSI Z223.1/NFPA 54, Section 5.3, Air for Combustion and Ventilation* for required size of ventilation grills or ducts.

IMPORTANT: Do not provide openings for inlet or outlet air into attic if attic has a thermostat-controlled power vent. Heated air entering the attic will activate the power vent.

VENTILATION AIR

Ventilation Air From Inside Building

This fresh air would come from an adjoining unconfined space. When ventilating to an adjoining unconfined space, you must provide two permanent openings: one within 12" of the ceiling and one within 12" of the floor on the wall connecting the two spaces (see options 1 and 2, Figure 2). You can also remove door into adjoining room (see option 3, Figure 2). Follow the *National Fuel Gas Code, ANSI Z223.1/NFPA 54, Section 5.3, Air for Combustion and Ventilation* for required size of ventilation grills or ducts.

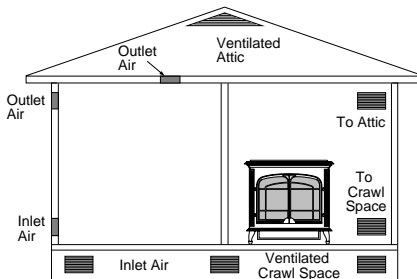

Figure 3 - Ventilation Air from Outdoors (Oxford™ Stove Model Shown)

INSTALLATION

NOTICE: This heater is intended for use as supplemental heat. Use this heater along with your primary heating system. Do not install this heater as your primary heat source. If you have a central heating system, you may run system's circulating blower while using heater. This will help circulate the heat throughout the house. In the event of a power outage, you can use this heater as your primary heat source.

⚠ WARNING: A qualified service person must install fireplace. Follow all local codes.

⚠ WARNING: Never install the heater

- in a bedroom or bathroom
- in a recreational vehicle
- where curtains, furniture, clothing, or other flammable objects are less than 42 inches from the front, top, or sides of the heater
- in high traffic areas
- in windy or drafty areas

⚠ CAUTION: This heater creates warm air currents. These currents move heat to wall surfaces next to heater. Installing heater next to vinyl or cloth wall coverings or operating heater where impurities (such as, but not limited to, tobacco smoke, aromatic candles, cleaning fluids, oil or kerosene lamps, etc.) in the air exist, may discolor walls or cause odors.

IMPORTANT: Vent-free heaters add moisture to the air. Although this is beneficial, installing heater in rooms without enough ventilation air may cause mildew to form from too much moisture. See *Air for Combustion and Ventilation*, pages 5 through 7.

CHECK GAS TYPE

Use only the correct type of gas (natural or propane/LP). If your gas supply is not the correct gas type, do not install heater. Call dealer where you bought heater for proper type heater.

⚠ WARNING: This appliance is equipped for (natural or propane/LP) gas. Field conversion is not permitted.

CLEARANCES TO COMBUSTIBLES

⚠ WARNING: Maintain the minimum clearances. If you can, provide greater clearances from floor, ceiling, and adjoining side and back walls.

Carefully follow the instructions below. This stove is a freestanding unit designed to set directly on the floor. **IMPORTANT:** You must maintain minimum wall and ceiling clearances during installation. The minimum clearances are shown in Figure 4, page 9. Measure from outermost point of stove top.

Minimum Wall and Ceiling Clearances (see Figure 4, page 9)

- A. Clearances from outermost point of stove top to any combustible side wall should not be less than 12 inches.
- B. Clearances from outermost point of stove top to any combustible back wall should not be less than 6 inches (includes corner installations).
- C. Clearances from the stove top to the ceiling should not be less than 48 inches.

INSTALLATION

Continued

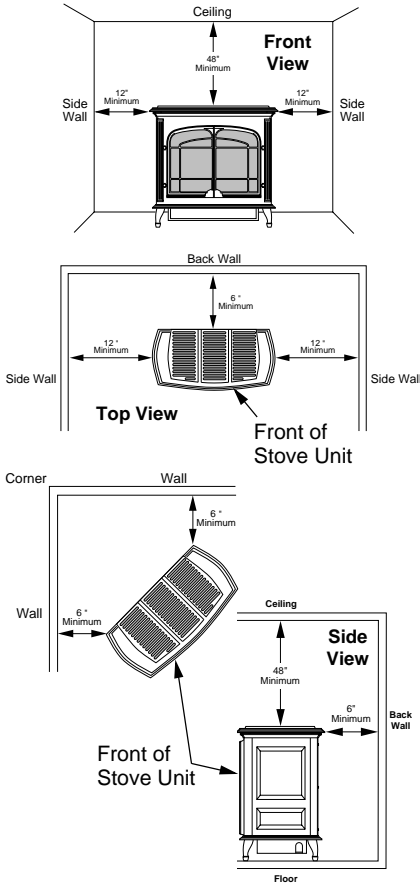

Figure 4 - Minimum Clearance to Walls and Ceiling (Stove May Vary Depending on Model)

STOVE CAVITY ASSEMBLY

1. Lift off corrugated box enclosing stove body crating.
2. Remove all screws fastening the wood frame enclosure. Spread wood frame open and lift away from plastic-bagged stove body. The bottom pieces of pallet wood will remain bolted to the stove body.
3. Remove plastic bag from stove body.

4. Remove all contents from inside stove cavity. Contents include:
 - (4) - Legs (include leg leveler bolts)
 - (1) - Bottom door
 - (3) - Top grates
 - (1) - Hardware kit bag with fasteners
5. Carefully lay stove body on back to attach bottom components to stove body (see Figure 5). Rest stove on drop cloth or blanket to avoid scratching stove edges.
6. Remove remaining pallet wood attached to bottom of stove body (see Figure 6). Use an adjustable wrench or 12mm socket to remove bolts.
7. Fasten each leg to stove with four (4) M8 x 1.25 - 20mm bolts. Use a flat washer and lock washer with each bolt. Tighten bolts into threaded holes on stove body (see Figures 7 and 8, page 10). Use an adjustable wrench or a 12mm socket.
8. Attach stove door by inserting step bolt through door hinge pivot hole and into threaded hole in stove body (see Figure 7 and Figure 10, page 10). Use an adjustable wrench or a 12mm socket to fasten step bolt. Tighten step bolt until snug. Make sure door moves freely.

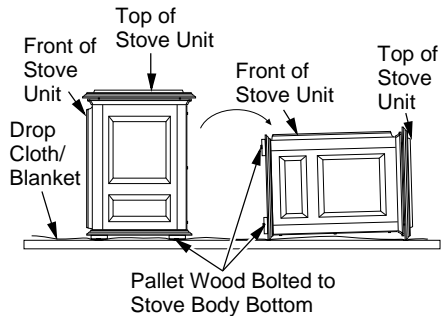

Figure 5 - Laying Down Stove On Side (Stove Style May Vary Depending on Model)

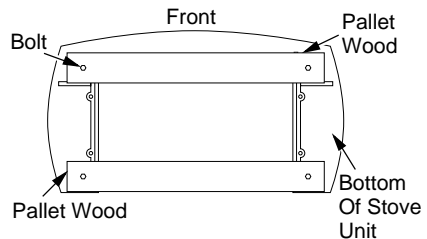
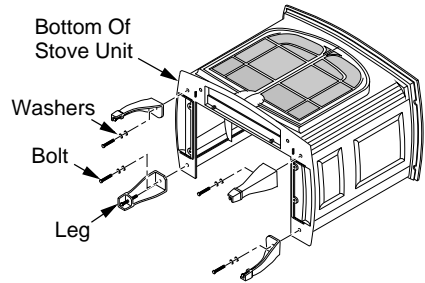

Figure 6 - Removing Pallet Wood From The Bottom of The Stove

INSTALLATION

Continued

10. Install door catch bolt (M8 x 1.25-55mm with two M8 hex nuts) into threaded hole on stove body (see Figure 7). Use an adjustable wrench or a 12mm socket. The catch bolt has two hex nuts attached to it (see Figure 11). The top nut is a bolt stop and the bottom nut is for door leveling adjustment.
11. Check general catch bolt alignment with door claw. Make final adjustment and door leveling after stove is in normal standing position.
12. Carefully lift stove back up on its four attached legs.
13. Remove gas log heater from carton. *Note:* Do not pick up gas log heater by the burner itself. This could damage heater. Always handle the gas log heater by the heater base only.
14. Fasten stove pan to stove with two (2) M6 x 1 - 25mm bolts. Use a flat washer and lock washer with each bolt. Tighten bolts into threaded holes on stove body (see Figures 7 and 9). Use an adjustable wrench or a 10mm socket.
15. Set top grates into stove top.



**Figure 8 - Attaching Stove Legs
(Oxford™ Model Shown)**

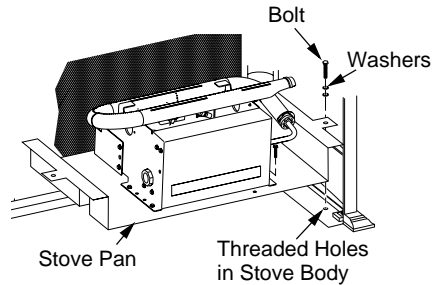

**Figure 9 - Attaching Stove Pan
(Oxford™ Model Shown)**

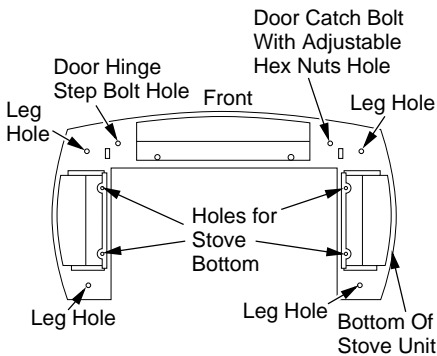

**Figure 7 - Locating Threaded Holes for
Stove Bottom, Legs, and Door
Attachment (Appearance May Vary
Depending on Model)**

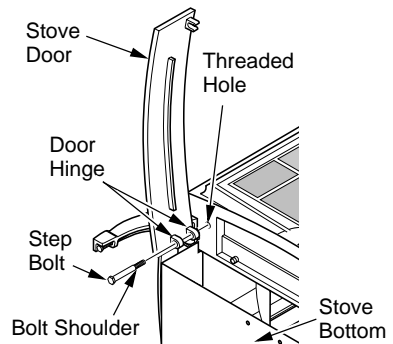

**Figure 10 - Attaching Stove Door
(Appearance May Vary Depending on Model)**

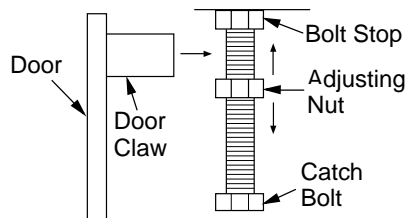

**Figure 11 - Catch Bolt and Door Claw
Orientation**

INSTALLATION

Continued

CAUTION: Do not remove the data plates attached to the heater base assembly. The data plates contain important warranty and safety information.

WARNING: Failure to position the parts in accordance with these diagrams or failure to use only parts specifically approved with this heater may result in property damage or personal injury.

INSTALLING GAS LOG INTO STOVE

1. Remove log from carton.
2. Remove all protective packaging applied to log for shipment.
3. Check log for any shipping damage. If damaged (pieces larger than the size of a dime), promptly inform dealer where you bought heater.
4. Set one-piece log on heater base as shown in Figure 12. Make sure middle section at bottom of log is seated into "U" shaped cutout in center of heater base. Log will fit securely on base. **IMPORTANT:** Make sure log does not cover any burner ports and does not touch the stove cavity (see Figure 13).
5. Fasten back panel to stove with four (4) M6 x 1 bolts and washers.
6. Place freestanding stove in desired position in room. Be sure to maintain clearances to combustibles as outlined on page 8.

CAUTION: After installation and periodically thereafter, check to ensure that no flame comes in contact with any log. With the heater set to HI, check to see if flames contact any log. If so, reposition logs according to the log installation instructions in this manual. Flames contacting logs will create soot.

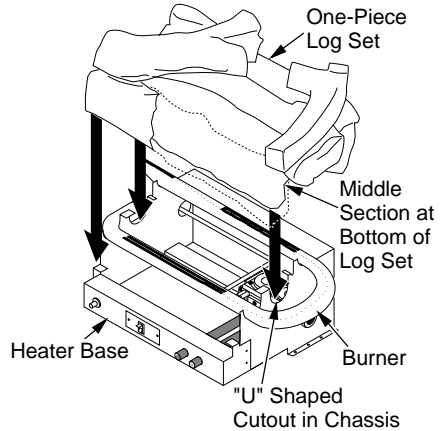

Figure 12 - Installing One-Piece Stove Log Set

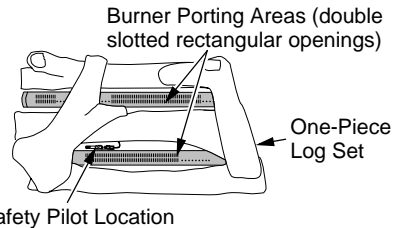

Figure 13 - Top View of One-Piece Log Set on Gas Log Heater

CONNECTING TO GAS SUPPLY

WARNING: This appliance requires a 1/2" NPT (National Pipe Thread) inlet connection to the pressure regulator.

WARNING: A qualified service person must connect heater to gas supply. Follow all local codes.

CAUTION: Never connect propane/LP heater directly to the propane/LP supply. This heater requires an external regulator (not supplied). Install the external regulator between the heater and propane/LP supply.

INSTALLATION

Continued

⚠ WARNING: Never connect natural gas heater to private (non-utility) gas wells. This gas is commonly known as wellhead gas.

Installation Items Needed

Before installing heater, make sure you have the items listed below.

- external regulator - propane/LP only (supplied by installer)
- piping (check local codes)
- sealant (resistant to propane/LP gas)
- equipment shutoff valve *
- test gauge connection *
- sediment trap
- tee joint
- pipe wrench

* A CSA design-certified equipment shutoff valve with 1/8" NPT tap is an acceptable alternative to test gauge connection. Purchase the optional CSA design-certified equipment shutoff valve from your dealer. See *Accessories*, page 27.

The gas inlet connection for the stove heater is located on the lower right-hand side of the stove when viewed from the front of the unit. The gas connection can be made either through the bottom right side or through the lower back opening as illustrated in Figure 14. Make sure gas log heater is secured to the stove cavity assembly.

For propane/LP units, installer must supply an external regulator. The external regulator will reduce incoming gas pressure. You must reduce incoming gas pressure to between 11 and 14 inches of water. If you do not reduce incoming gas pressure, heater regulator damage could occur. Install external regulator with the vent pointing down as shown in Figure 15. Pointing the vent down protects it from freezing rain or sleet.

⚠ CAUTION: Use only new, black iron or steel pipe. Internally-tinned copper tubing may be used in certain areas. Check your local codes. Use pipe of 1/2" diameter or greater to allow proper gas volume to heater. If pipe is too small, undue loss of volume will occur.

Installation must include a equipment shutoff valve, union, and plugged 1/8" NPT tap. Locate NPT tap within reach for test gauge hook up. NPT tap must be upstream from heater (see Figure 16 on page 13).

IMPORTANT: Install equipment shutoff valve in an accessible location. The equipment shutoff valve is for turning on or shutting off the gas to the appliances.

Check your building codes for any special requirements for locating equipment shutoff valve to fireplaces.

Apply pipe joint sealant lightly to male threads. This will prevent excess sealant from going into pipe. Excess sealant in pipe could result in clogged heater valves.

⚠ WARNING: Use pipe joint sealant that is resistant to liquid petroleum (LP) gas.

We recommend that you install a sediment trap in supply line as shown in Figure 16, page 13. Locate sediment trap where it is within reach for cleaning. Install in piping system between fuel supply and heater. Locate sediment trap where trapped matter is not likely to freeze. A sediment trap traps moisture and contaminants. This keeps them from going into heater controls. If sediment trap is not installed or is installed wrong, heater may not run properly.

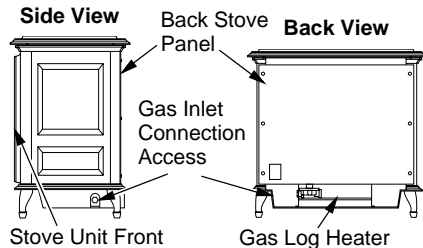

Figure 14 - Gas Regulator Location and Gas Line Access Into Stove Cabinet

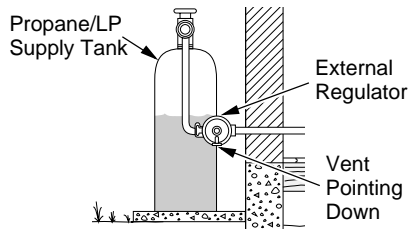

Figure 15 - External Regulator With Vent Pointing Down

INSTALLATION

Continued

CAUTION: Avoid damage to regulator. Hold gas regulator with wrench when connecting it to gas piping and/or fittings.

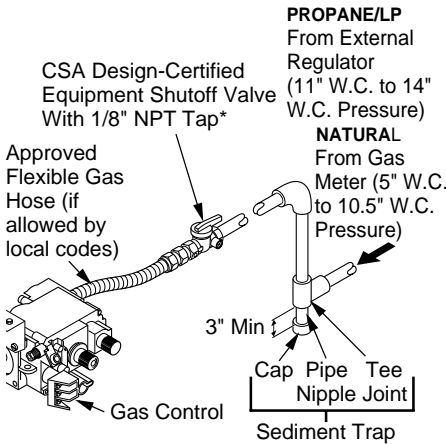

Figure 16 - Gas Connection (SVYD18PRA/NRA Series)

* Purchase the optional CSA design-certified equipment shutoff valve from your dealer. See *Accessories*, page 27.

** Minimum inlet pressure for purpose of input adjustment.

CHECKING GAS CONNECTIONS

WARNING: Test all gas piping and connections, internal and external to unit, for leaks after installing or servicing. Correct all leaks at once.

WARNING: Never use an open flame to check for a leak. Apply a noncorrosive leak detection fluid to all joints. Bubbles forming show a leak. Correct all leaks at once.

CAUTION: Make sure external regulator has been installed between propane/LP supply and heater. See guidelines under *Connecting to Gas Supply*, page 11.

Pressure Testing Gas Supply Piping System

Test Pressures In Excess Of 1/2 PSIG (3.5 kPa)

1. Disconnect appliance with its appliance main gas valve (control valve) and equipment shutoff valve from gas supply piping system. Pressures in excess of 1/2 psig will damage heater regulator.
2. Cap off open end of gas pipe where equipment shutoff valve was connected.
3. Pressurize supply piping system by either opening propane/LP supply tank valve for propane/LP gas or opening main gas valve located on or near gas meter for natural gas, or using compressed air.
4. Check all joints of gas supply piping system. Apply a noncorrosive leak detection fluid to gas joints. Bubbles forming show a leak.
5. Correct all leaks at once.
6. Reconnect heater and equipment shutoff valve to gas supply. Check reconnected fittings for leaks.

Test Pressures Equal To or Less Than 1/2 PSIG (3.5 kPa)

1. Close equipment shutoff valve (see Figure 17).
2. Pressurize supply piping system by either opening propane/LP supply tank valve for propane/LP gas or opening main gas valve located on or near gas meter for natural gas, or using compressed air.
3. Check all joints from gas meter for natural or propane/LP supply to equipment shutoff valve (see Figure 18 or 19, page 14). Apply a non-corrosive leak detection fluid to gas joints. Bubbles forming show a leak.
4. Correct all leaks at once.

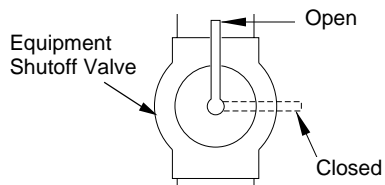

Figure 17 - Equipment Shutoff Valve

INSTALLATION

Continued

Pressure Testing Heater Gas Connections

1. Open equipment shutoff valve (see Figure 17, page 13).
2. Open main gas valve located on or near gas meter for natural gas or open propane/LP supply tank valve.
3. Make sure control knob of heater is in the OFF position.
4. Check all joints from equipment shutoff valve to control valve (see Figure 18 or 19). Apply a noncorrosive leak detection fluid to gas joints. Bubbles forming show a leak.
5. Correct all leaks at once.
6. Light heater (see *Operating Heater*, pages 14 through 17). Check all other internal joints for leaks.
7. Turn off heater (see *To Turn Off Gas to Appliance*, page 15).

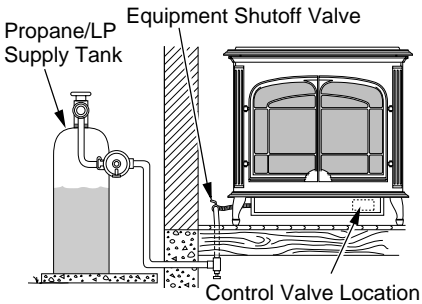

**Figure 18 - Checking Gas Joints
(Oxford™ Stove Model Shown)**

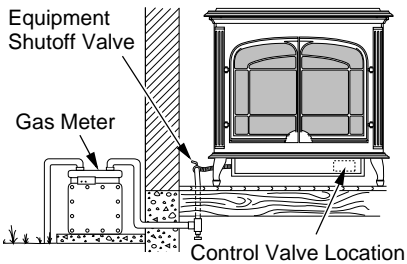

**Figure 19 - Checking Gas Joints
(Oxford™ Stove Model Shown)**

OPERATING HEATER

FOR YOUR SAFETY READ BEFORE LIGHTING

WARNING: If you do not follow these instructions exactly, a fire or explosion may result causing property damage, personal injury or loss of life.

- A. This appliance has a pilot which must be lighted by hand. When lighting the pilot, follow these instructions exactly.
- B. **BEFORE LIGHTING** smell all around the appliance area for gas. Be sure to smell next to the floor because some gas is heavier than air and will settle on the floor.
WHAT TO DO IF YOU SMELL GAS
 - Do not try to light any appliance.
 - Do not touch any electric switch; do not use any phone in your building.
 - Immediately call your gas supplier from a neighbor's phone. Follow the gas supplier's instructions.
 - If you cannot reach your gas supplier, call the fire department.
- C. Use only your hand to push in or turn the gas control knob. Never use tools. If the knob will not push in or turn by hand, don't try to repair it, call a qualified service technician or gas supplier. Force or attempted repair may result in a fire or explosion.
- D. Do not use this appliance if any part has been under water. Immediately call a qualified service technician to inspect the appliance and to replace any part of the control system and any gas control which has been under water.

LIGHTING INSTRUCTIONS



NOTICE: During initial operation of new heater, burning logs will give off a paper-burning smell. Open window to vent smell. This will only last a few hours.

1. STOP! Read the safety information above.
2. Make sure equipment shutoff valve is fully open.
3. Set switch to OFF position.

OPERATING HEATER

Continued

⚠ WARNING: Burners will come on automatically within one minute when the remote selector switch is in the ON position after the pilot is lit.

- Press in and turn control knob clockwise  to the OFF position.
- Wait five (5) minutes to clear out any gas. Then smell for gas, including near the floor. If you smell gas, STOP! Follow "B" in the safety information in column 2, page 14. If you don't smell gas, go to the next step.
- Press in and turn control knob counterclockwise  to the PILOT position. Press in control knob for five (5) seconds (see step 5).

Note: You may be running this heater for the first time after hooking up to gas supply. If so, the control knob may need to be pressed in for 30 seconds or more. This will allow air to bleed from the gas system.

- With control knob pressed in, press and release ignitor button. This will light pilot. The pilot is attached to the front burner (see Figure 13, page 11). If needed, keep pressing ignitor button until pilot lights.

Note: If pilot does not stay lit, contact a qualified service person or gas supplier for repairs. Until repairs are made, light pilot with match. To light pilot with match, see *Manual Lighting Procedure*, page 16.

- Keep control knob pressed in for 30 seconds after lighting pilot. After 30 seconds, release control knob.

• If control knob does not pop out when released, contact a qualified service person or gas supplier for repairs.

Note: If pilot goes out, repeat steps 4 through 8.

- Slightly push in and turn control knob counterclockwise  to the ON position.

- Wait one minute and switch remote selector switch to the ON position to light burners.

Note: AUTO is only functional when using GWMT1 or GWMS2 optional accessories.

- Set flame adjustment knob to any level between HI and LO.

⚠ CAUTION: Do not try to adjust heating levels by using the equipment shutoff valve.

⚠ WARNING: Make sure the selector switch is in the OFF position when you are away from home for long periods of time. Heater will come on automatically with selector switch in the ON position.

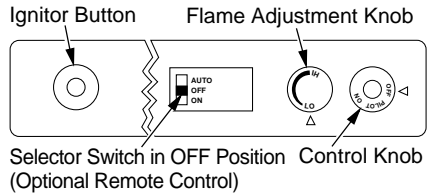

Figure 20 - Control Knob and Ignitor Button Location (Shown as Supplied, No Control Options)

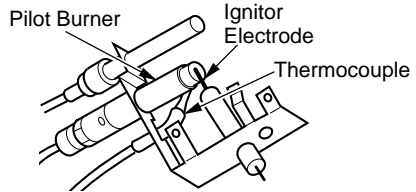



Figure 21 - Pilot

TO TURN OFF GAS TO APPLIANCE

Shutting Off Heater

- Turn control knob clockwise  to the OFF position.
- Set selector switch in the OFF position to keep from draining battery.

Shutting Off Burners Only (pilot stays lit)
You may shut off the burners and keep the pilot lit by doing one of the following:

- Turn control knob clockwise  to the PILOT position.
- Use remote control manual OFF button.
- Set remote selector switch in the OFF position.

OPERATING HEATER

Continued

MANUAL LIGHTING PROCEDURE

1. Follow steps 1 through 6 under *Lighting Instructions*, page 15.
2. Depress control knob and light pilot with match.
3. Keep control knob pressed in for 30 seconds after lighting pilot. After 30 seconds, release control knob. Now follow steps 9 through 11 under *Lighting Instructions*, page 15.

OPTIONAL HAND-HELD REMOTE OPERATION

Note: All remote control accessories must be purchased separately (see *Accessories*, page 27). Follow instructions included with the remote control.

NOTICE: You must light the pilot before using the hand-held remote control unit. See *Lighting Instructions* on pages 14 and 15.

1. After lighting, let pilot flame burn for about one minute. Turn control knob to ON position. Adjust flame adjustment knob anywhere between HI and LO. Slide the selector switch to the REMOTE position (see Figure 22). **Note:** The burner may light if hand-held remote was on when selector switch was last turned off. You can now turn the burner on and off with the hand-held remote control unit.

IMPORTANT: Do not leave the selector switch in the REMOTE or ON position when the pilot is not lit. This will drain the battery.

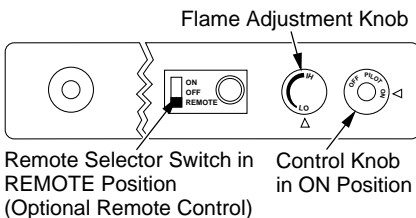

Figure 22 - Setting the Remote Selector Switch, Control Knob, and Flame Adjustment Knob for Remote Operation

ON/OFF SERIES (MODEL GHRCB)

Hold the control button on the hand-held remote until burner turns on. Hold the control button again until burner turns off (see Figure 23).

TO LOCK press both buttons on hand-held remote control until light stops flashing. Hand-held remote control is now locked. If the fire is on it will be turned off automatically. In the locked state, the light will not light up when any button is pressed.

TO UNLOCK press both buttons together on hand-held remote control until the light stops flashing. The hand-held remote is now unlocked.

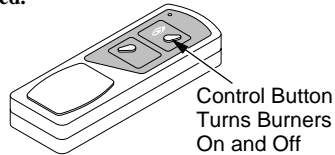

Figure 23 - On/Off Hand-Held Remote Control Unit (GHRCB)

THERMOSTAT SERIES (MODEL GHRCTB)

The hand-held remote can be operated using either the manual mode (MANU) or thermostat mode (AUTO) (see Figure 24). To select Fahrenheit/Centigrade mode display, carefully press the °C/°F mode button with the end of a paper clip or similar blunt object.

Manual Mode

1. Press the POWER and LOCK buttons together to turn on the hand-held remote control.
2. Press the MANU button to turn on the heater.

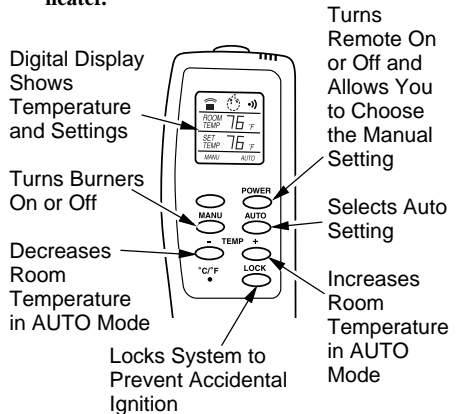

Figure 24 - Thermostat Hand-Held Remote Control Unit (GHRCTB)

OPERATING HEATER

Continued

3. Press the **POWER** and **LOCK** buttons together to turn off the heater.

Auto (Thermostatic) Mode

1. Press the **POWER** and **LOCK** buttons together to turn on the hand-held remote control.
2. Press **AUTO** button to select this mode.
3. Set the desired room temperature by pressing the **TEMP +** or **-** buttons.
4. Press the **POWER** and **LOCK** buttons together to turn off the fireplace

Note: Do not leave the hand-held remote in the **AUTO** mode close to the fireplace. The radiant heat from the fireplace will turn off the fireplace. Ideally, place the hand-held remote in the center of the room facing towards the fireplace.

Note: Do not hold the hand-held remote for a long time. Body temperature will affect its operation in the **AUTO** mode.

Safety Features

When away from home for an extended period of time or as a child safety feature to prevent accidental ignition of the fireplace, the receiver **ON/OFF/REMOTE** switch should be in the **OFF** position.

Auto Shutoff Feature

1. If the average room temperature exceeds 82 degrees Fahrenheit (28 degrees Centigrade), the hand-held remote control will perform a safety override and shut the fireplace off. This feature is not available in the **MANU** mode.
2. The receiver continuously receives signals from the hand-held remote to control the room temperature. If the hand-held remote is misplaced, obstructed, or for any reason cannot transmit to the receiver, the receiver will shut off the fireplace after 8 minutes.

Key Pad Lock Feature

This feature allows the user to lock/unlock the keypad on the hand-held remote in the **MANU** or **AUTO** mode to prevent inadvertent operation (i.e. children operating the hand-held remote control, etc.). The keypad is locked in either on or off. Press the **POWER** and **LOCK** buttons together to turn the unit on or off.

INSPECTING BURNERS

Check pilot flame pattern and burner flame patterns often.

PILOT FLAME PATTERN

Figure 25 shows a correct pilot flame pattern. Figure 26 shows an incorrect pilot flame pattern. The incorrect pilot flame is not heating the thermocouple. This will cause the thermocouple to cool. When the thermocouple cools, the heater will shut down.

If pilot flame pattern is incorrect, as shown in Figure 26

- turn heater off (see *To Turn Off Gas to Appliance*, page 15)
- see *Troubleshooting*, pages 19 through 21

Note: The pilot flame on natural gas units will have a slight curve, but flame should be blue and have no yellow or orange color.

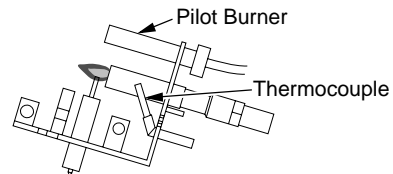

Figure 25 - Correct Pilot Flame Pattern (Propane/LP Shown)

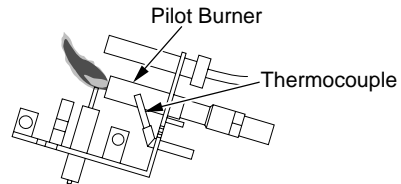

Figure 26 - Incorrect Pilot Flame Pattern (Propane/LP Shown)

BURNER PRIMARY AIR HOLES

Air is drawn into the burner through the holes in the fitting at the burner entrance. These holes may become blocked with dust or lint. Periodically inspect these holes for any blockage and clean if needed. Blocked air holes will create soot.

MAIN BURNER

Periodically inspect all burner flame holes with the heater running. All slotted burner flame holes should be open with yellow flame present. All round burner flame holes should be open with a small blue flame present. Some burner flame holes may become blocked by debris or rust, with no flame present. If so, turn off heater and let cool. Remove blockage. Blocked burner flame holes will create soot.

CLEANING AND MAINTENANCE

⚠ WARNING: Turn off heater and let cool before cleaning.

⚠ CAUTION: You must keep control areas, burner, and circulating air passageways of heater clean. Inspect these areas of heater before each use. Have heater inspected yearly by a qualified service person. Heater may need more frequent cleaning due to excessive lint from carpeting, pet hair, bedding material, etc.

⚠ WARNING: Failure to keep the primary air opening(s) of the burner(s) clean may result in sooting and property damage.

BURNER INJECTOR HOLDER AND PILOT AIR INLET HOLE

The primary air inlet holes allow the proper amount of air to mix with the gas. This provides a clean burning flame. Keep these holes clear of dust, dirt, lint, and pet hair. Clean these air inlet holes prior to each heating season. Blocked air holes will create soot. We recommend that you clean the unit every three months during operation and have heater inspected yearly by a qualified service person.

We also recommend that you keep the burner tube and pilot assembly clean and free of dust and dirt. To clean these parts we recommend using compressed air no greater than 30 PSI. Your local computer store, hardware store, or home center may carry compressed air in a can. You can use a vacuum cleaner in the blow position. If using compressed air in a can, please follow the directions on the can. If you don't follow directions on the can, you could damage the pilot assembly. Note: Removing the rear panel (Figure 5, page 8) and top grate(s) of your stove will make cleaning easier.

1. Shut off the unit, including the pilot. Allow the unit to cool for at least thirty minutes.
2. Inspect burner, pilot, and primary air inlet holes on injector holder for dust and dirt (see Figure 27).
3. Blow air through the ports/slots and holes in the burner.
4. Check the injector holder located at the end of the burner tube again. Remove any large particles of dust, dirt, lint, or pet hair with a soft cloth or vacuum cleaner nozzle.
5. Blow air into the primary air holes on the injector holder.
6. In case any large clumps of dust have now been pushed into the burner repeat steps 3 and 4.

Clean the pilot assembly also. A yellow tip on the pilot flame indicates dust and dirt in the pilot assembly. There is a small pilot air inlet hole about two inches from where the pilot flame comes out of the pilot assembly (see Figure 28). With the unit off, lightly blow air through the air inlet hole. You may blow through a drinking straw if compressed air is not available.

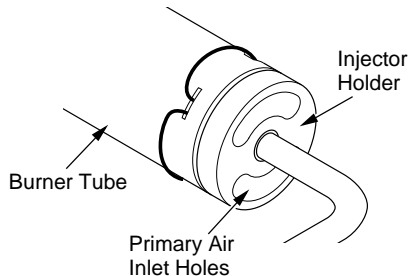

Figure 27 - Injector Holder On Outlet Burner Tube

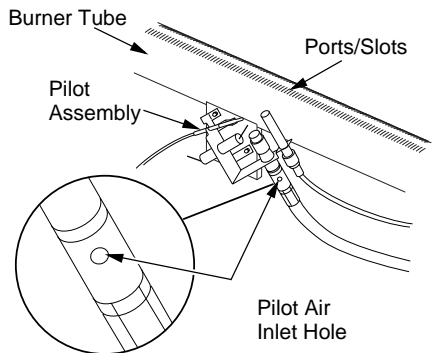

Figure 28 - Pilot Inlet Air Hole

TROUBLESHOOTING

Note: All troubleshooting items are listed in order of operation.

⚠ WARNING: Turn off heater and let cool before servicing. Only a qualified service person should service and repair heater.

⚠ CAUTION: Never use a wire, needle, or similar object to clean ODS/pilot. This can damage ODS/pilot unit.

OBSERVED PROBLEM	POSSIBLE CAUSE	REMEDY
When ignitor button is pressed, there is no spark at ODS/pilot	<ol style="list-style-type: none"> 1. Ignitor electrode not connected to ignitor cable 2. Ignitor cable pinched or wet 3. Broken ignitor cable 4. Bad piezo ignitor 5. Ignitor electrode broken 6. Ignitor electrode positioned wrong 	<ol style="list-style-type: none"> 1. Reconnect ignitor cable 2. Free ignitor cable if pinched by any metal or tubing. Keep ignitor cable dry 3. Replace ignitor cable 4. Replace piezo ignitor 5. Replace pilot assembly 6. Replace pilot assembly
When ignitor button is pressed, there is spark at ODS/pilot but no ignition	<ol style="list-style-type: none"> 1. Gas supply turned off or equipment shutoff valve closed 2. Control knob not in PILOT position 3. Control knob not pressed in while in PILOT position 4. Air in gas lines when installed 5. ODS/pilot is clogged 6. Gas regulator setting is not correct 7. Depleted gas supply (propane/LP only) 	<ol style="list-style-type: none"> 1. Turn on gas supply or open equipment shutoff valve 2. Turn control knob to PILOT position 3. Press in control knob while in PILOT position 4. Continue holding down control knob. Repeat igniting operation until air is removed 5. Clean ODS/pilot (see <i>Cleaning and Maintenance</i>, page 18) or replace ODS/pilot assembly 6. Replace gas control 7. Contact local propane/LP gas company
ODS/pilot lights but flame goes out when control knob is released	<ol style="list-style-type: none"> 1. Control knob not fully pressed in 2. Control knob not pressed in long enough 3. Equipment shutoff valve not fully open 4. Pilot flame not touching thermocouple, which allows thermocouple to cool, causing pilot flame to go out. This problem could be caused by one or both of the following: <ol style="list-style-type: none"> A) Low gas pressure B) Dirty or partially clogged ODS/pilot 5. Thermocouple connection loose at control valve 6. Thermocouple damaged 7. Control valve damaged 	<ol style="list-style-type: none"> 1. Press in control knob fully 2. After ODS/pilot lights, keep control knob pressed in 30 seconds 3. Fully open equipment shutoff valve 4. A) Contact local propane/LP or natural gas company B) Clean ODS/pilot (see <i>Cleaning and Maintenance</i>, page 18) or replace ODS/pilot assembly 5. Hand tighten until snug, then tighten 1/4 turn more 6. Replace pilot assembly 7. Replace control valve

TROUBLESHOOTING

Continued

OBSERVED PROBLEM	POSSIBLE CAUSE	REMEDY
Burner does not light after ODS/pilot is lit	<ol style="list-style-type: none">1. Burner orifice clogged2. Inlet gas pressure is too low3. Thermopile leads disconnected or improperly connected4. Burners will not come on in remote position	<ol style="list-style-type: none">1. Clean burner (see <i>Cleaning and Maintenance</i>, page 18) or replace burner orifice2. Contact local propane/LP or natural gas company3. Reconnect leads (see <i>Wiring Diagram</i>, page 26)4. Replace battery in transmitter and hand-held remote
Delayed ignition burner	<ol style="list-style-type: none">1. Manifold pressure is too low2. Burner orifice clogged	<ol style="list-style-type: none">1. Contact local propane/LP or natural gas company2. Clean burner (see <i>Cleaning and Maintenance</i>, page 18) or replace burner orifice
Burner backfiring during combustion	<ol style="list-style-type: none">1. Burner orifice is clogged or damaged2. Damaged burner3. Gas regulator defective	<ol style="list-style-type: none">1. Clean burner (see <i>Cleaning and Maintenance</i>, page 18) or replace burner orifice2. Replace damaged burner3. Replace gas control
Slight smoke or odor during initial operation	<ol style="list-style-type: none">1. Not enough air2. Gas regulator defective3. Residues from manufacturing processes and logs curing	<ol style="list-style-type: none">1. Check burner for dirt and debris. If found, clean burner (see <i>Cleaning and Maintenance</i>, page 18)2. Replace gas control3. Problem will stop after a few hours of operation
Moisture/condensation noticed on windows	<ol style="list-style-type: none">1. Not enough combustion/ventilation air	<ol style="list-style-type: none">1. Refer to <i>Air for Combustion and Ventilation</i> requirements (page 5)
Heater produces a whistling noise when burner is lit	<ol style="list-style-type: none">1. Turning control knob to HI position when burner is cold2. Air in gas line3. Air passageways on heater blocked4. Dirty or partially clogged burner orifice	<ol style="list-style-type: none">1. Turn control knob to LO position and let warm up for a minute2. Operate burner until air is removed from line. Have gas line checked by local propane/LP or natural gas company3. Observe minimum installation clearances (see page 8)4. Clean burner (see <i>Cleaning and Maintenance</i>, page 18) or replace burner orifice
Dark residue on logs or inside of fireplace	<ol style="list-style-type: none">1. Improper log placement2. Drafts or other air currents affecting flame pattern3. Air holes at burner inlet blocked4. Burner flame holes blocked	<ol style="list-style-type: none">1. Properly locate logs (see <i>Installing Gas Log Into Stove</i>, page 11)2. Eliminate source of drafts around heater3. Clean out air holes at burner inlet. Periodically repeat as needed4. Remove blockage or replace burner

TROUBLESHOOTING

Continued

OBSERVED PROBLEM	POSSIBLE CAUSE	REMEDY
White powder residue forming within burner box or on adjacent walls or furniture	1. When heated, vapors from furniture polish, wax, carpet cleaners, etc. may turn into white powder residue	1. Turn heater off when using furniture polish, wax, carpet cleaners, or similar products
Remote does not function	1. Battery is not installed. Battery power is low	1. Replace 9-volt batteries in receiver and hand-held remote control
Heater produces a clicking/ticking noise just after burner is lit or shut off	1. Metal expanding while heating or contracting while cooling	1. This is common with most heaters. If noise is excessive, contact qualified service person



WARNING: If you smell gas

- **Shut off gas supply.**
- **Do not try to light any appliance.**
- **Do not touch any electrical switch; do not use any phone in your building.**
- **Immediately call your gas supplier from a neighbor's phone. Follow the gas supplier's instructions.**
- **If you cannot reach your gas supplier, call the fire department.**

IMPORTANT: Operating fireplace where impurities in air exist may create odors. Cleaning supplies, paint, paint remover, cigarette smoke, cements and glues, new carpet or textiles, etc., create fumes. These fumes may mix with combustion air and create odors. These odors will disappear over time.

OBSERVED PROBLEM	POSSIBLE CAUSE	REMEDY
Heater produces unwanted odors	1. Heater burning vapors from paint, hair spray, glues, cleaners, chemicals, new carpet, etc. (See <i>IMPORTANT</i> statement above) 2. Gas leak. See Warning statement at top of page	1. Open window and ventilate room. Stop using odor causing products while heater is running 2. Locate and correct all leaks (see <i>Checking Gas Connections</i> , pages 13 and 14)
Heater shuts off in use (ODS operates)	1. Not enough fresh air is available 2. Low line pressure 3. ODS/pilot is partially clogged	1. Open window and/or door for ventilation 2. Contact local propane/LP or natural gas company 3. Clean ODS/pilot (see <i>Cleaning and Maintenance</i> , page 18)
Gas odor even when control knob is in OFF position	1. Gas leak. See Warning statement at top of page 2. Control valve defective	1. Locate and correct all leaks (see <i>Checking Gas Connections</i> , pages 13 and 14) 2. Replace control valve
Gas odor during combustion	1. Foreign matter between control valve and burner 2. GAS LEAK. SEE WARNING STATEMENT AT TOP OF PAGE	1. Take apart gas tubing and remove foreign matter 2. Locate and correct all leaks (see <i>Checking Gas Connections</i> , pages 13 and 14)

ILLUSTRATED PARTS BREAKDOWN MODELS SVYD18PRA AND SVYD18NRA

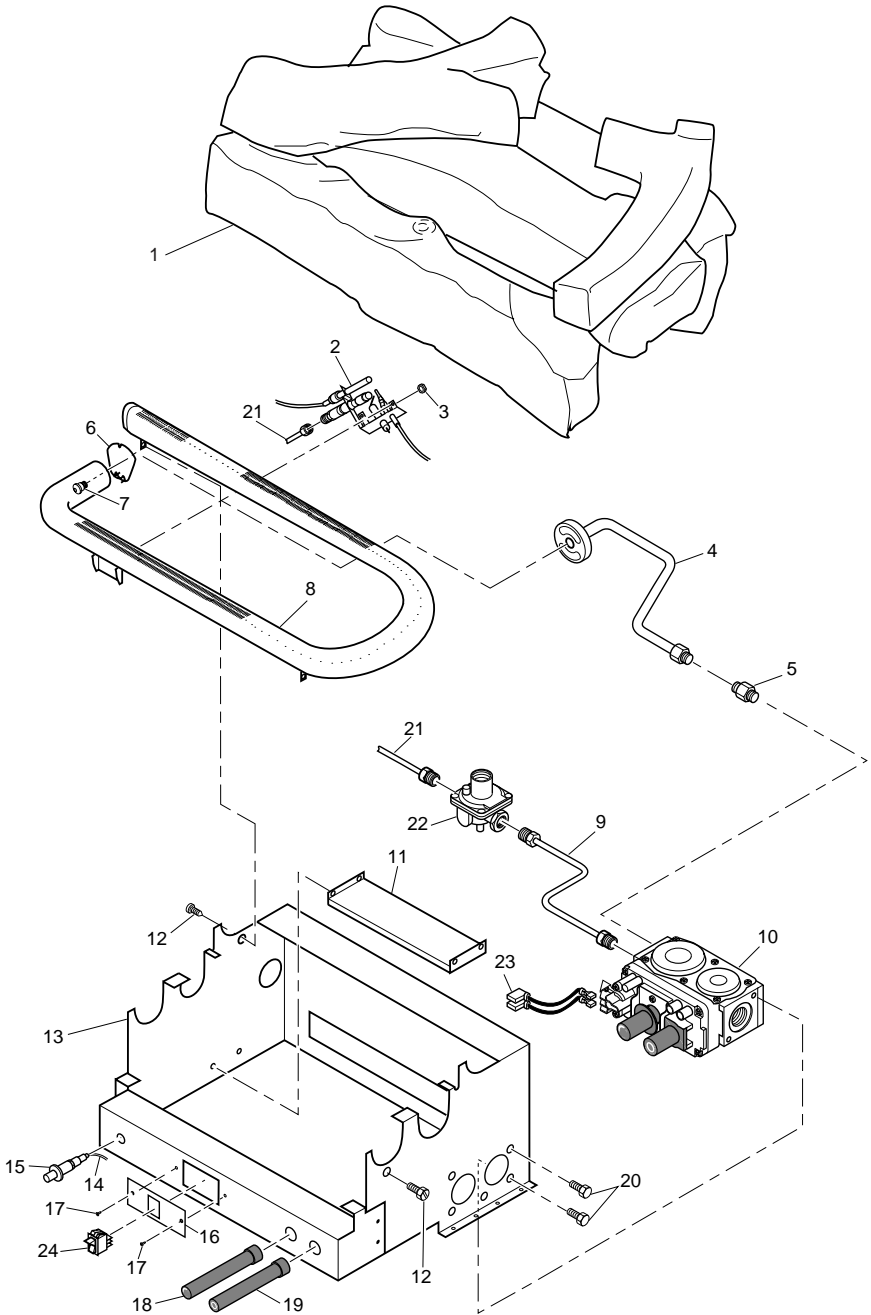

PARTS LIST

This list contains replaceable parts used in your heater. When ordering parts, follow the instructions listed under *Replacement Parts* on page 26 of this manual.

KEY NO.	PART NUMBER		DESCRIPTION	QTY.
	SVYD18PRA	SVYD18NRA		
1	104026-01	104026-01	Stove Log	1
2	103778-01	103779-01	ODS Pilot (LP)	1
3	098249-01	098249-01	ODS Nut	2
4	104423-02	104423-01	Burner Outlet Tube	1
5	098264-02	098264-02	Male Connector	1
6	111124-01	111124-01	Burner Retainer Spring	1
7	099056-19	099056-26	Burner Orifice Injector	1
8	102980-01	102980-01	Burner	1
9	099387-13	099387-15	Pilot Tube	1
10	103781-02	103781-01	Gas Control Valve	1
11	103345-02	103345-02	Lower Bracket	1
12	M11084-38	M11084-38	Screw, #8 x .38	7
13	104383-02CK	104383-02CK	Painted Base Assy	1
14	098271-10	098271-10	Ignitor Cable	1
15	102445-01	102445-01	Piezo Ignitor	1
16	103587-02	103587-02	Plate, Switch	1
17	098304-01	098304-01	Screw	2
18	103784-04	103784-04	Flame Adjustment Knob Extension	1
19	103784-03	103784-03	Off-Pilot-On Knob Extension	1
20	M12461-26	M12461-26	Screw, Hex Slit Wsr 10-32 x .38	4
21	—	100609-01	Pilot Tube (Regulator to Pilot)	1
22	—	099918-02	Pilot Regulator	1
23	103284-02	103284-02	Wiring Harness	1
24	099998-01	099998-01	Switch	1
PARTS AVAILABLE — NOT SHOWN				
	100563-01	100563-01	Warning Plate	1
	103877-01	103877-01	Lighting Instructions Plate	1
	100565-01	100565-01	Warning Plate Fastener	1
	101137-04	101137-04	Hardware Kit	1

ILLUSTRATED PARTS BREAKDOWN

Oxford™
VCIS(*) Series and PVCIS(*) Series
Victor Hearth™
VH(*)A Series
(* Indicates Color Suffix Designation)

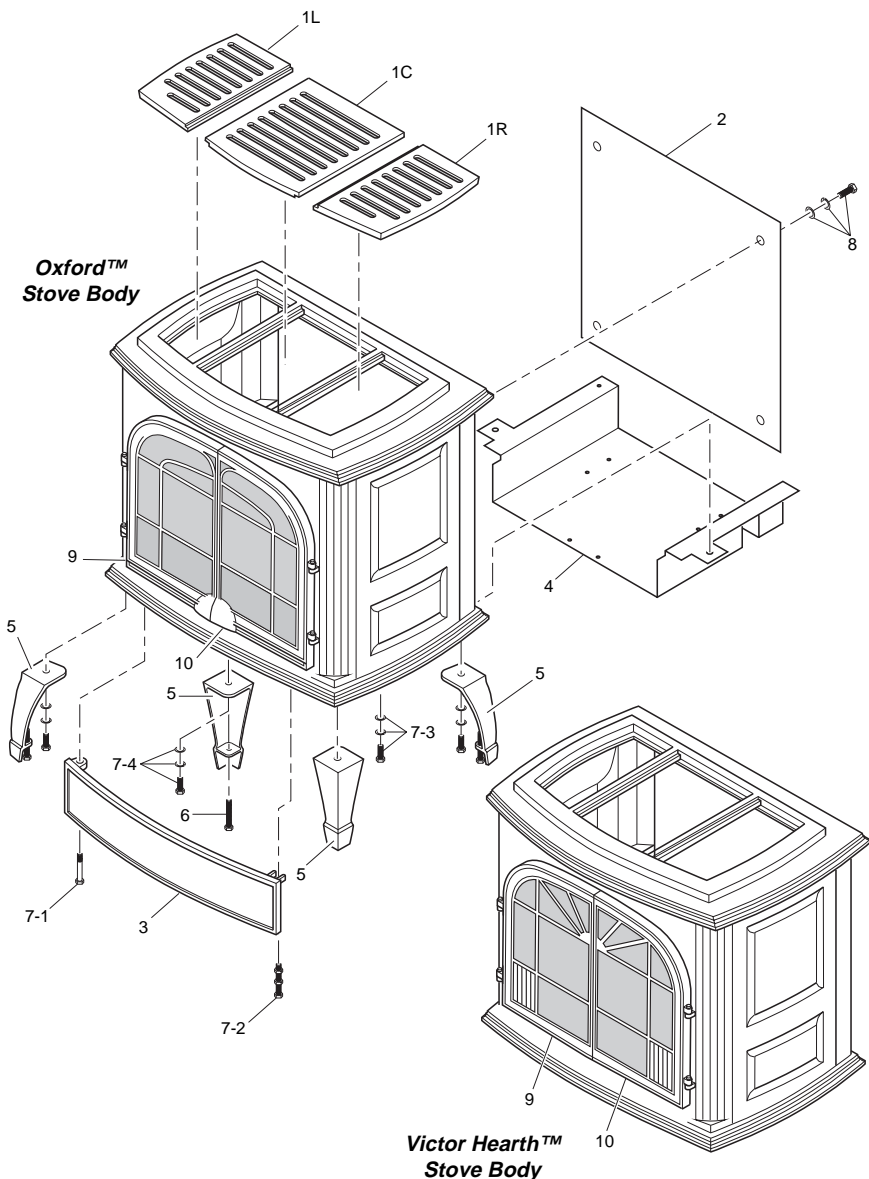

PARTS LIST

Oxford™
VCIS(*) Series and PVCIS(*) Series
Victor Hearth™
VH(*)A Series
(* Indicates Color Suffix Designation)

This list contains replaceable parts used in your heater. When ordering parts, follow the instructions listed under *Replacement Parts* on page 26 of this manual.

KEY NO.	PART NO.	DESCRIPTION	QTY.
1L	104171-11	Top Grate with Screen - Left (Black Only)	1
1C	104171-08	Top Grate with Screen - Center (Black Only)	1
1R	104171-12	Top Grate with Screen - Right (Black Only)	1
2	111532-01CK	Stove Back Panel (Black Only)	1
3	104173-01	Bottom Door (Charcoal)	1
	104173-07	Bottom Door (Porcelain Enamel Red)	1
	104173-08	Bottom Door (Porcelain Enamel Green)	1
	104173-09	Bottom Door (Porcelain Enamel Sand)	1
	104173-23	Bottom Door (Porcelain Enamel Black)	1
4	111531-02CK	Stove Dropped Bottom	1
5	104175-01	One Leg (Charcoal) (4 Total Per Stove)	1
	104175-07	One Leg (Porcelain Enamel Red) (4 Total Per Stove)	1
	104175-08	One Leg (Porcelain Enamel Green) (4 Total Per Stove)	1
	104175-09	One Leg (Porcelain Enamel Sand) (4 Total Per Stove)	1
	104175-44	One Leg (Porcelain Enamel Black) (4 Total Per Stove)	1
6	104176-01	Leg Leveler bolt M8 x 1.25 - 55mm Long (4 Total Per Stove)	1
7	104177-01	Hardware Kit	1
7-1	**	Door Hinge Step Bolt With Shoulder (1 Per Unit)	1
7-2	**	Door Catch Bolt M8 x 1.25 - 55mm Long With Two M8 Hex Nuts (1 Per Unit)	1
7-3	**	Bottom Floor Bolts M6 x 1 - 25mm Long With Flat Washer And Lock Washer (4 Per Unit)	1
7-4	**	Leg Bolts M8 x 1.25 - 20mm Long With Flat Washer And Lock Washer (4 Per Unit)	1
8	104178-01	Back Panel Bolts M6 x 1 - 20mm Long With Flat Washer And Lock Washer (4 Per Unit)	1
9	113086-01	Left Door, Black (Oxford™ Only)	1
	113086-02	Left Door, Porcelain Black (Oxford™ Only)	1
	113086-03	Left Door, Porcelain Green (Oxford™ Only)	1
	113086-04	Left Door, Porcelain Red (Oxford™ Only)	1
	113086-05	Left Door, Porcelain Sand (Oxford™ Only)	1
	111972-01	Left Door, Black (Victor Hearth™ Only)	1
	111972-02	Left Door, Porcelain Enamel Black (Victor Hearth™ Only)	1
	111972-03	Left Door, Porcelain Enamel Green (Victor Hearth™ Only)	1
10	113087-01	Right Door, Black (Oxford™ Only)	1
	113087-02	Right Door, Porcelain Black (Oxford™ Only)	1
	113087-03	Right Door, Porcelain Green (Oxford™ Only)	1
	113087-04	Right Door, Porcelain Red (Oxford™ Only)	1
	113087-05	Right Door, Porcelain Sand (Oxford™ Only)	1
	111972-04	Right Door, Black (Victor Hearth™ Only)	1
	111972-05	Right Door, Porcelain Enamel Black (Victor Hearth™ Only)	1
	111972-06	Right Door, Porcelain Enamel Green (Victor Hearth™ Only)	1
PARTS AVAILABLE — NOT SHOWN			
	104108-01	Touch-up Spray Paint 12 oz Can (Charcoal)	1
	104807-01	Touch-up Paint Bottle with Brush (Porcelain Enamel Red)	1
	104807-02	Touch-up Paint Bottle with Brush (Porcelain Enamel Green)	1
	104807-03	Touch-up Paint Bottle with Brush (Porcelain Enamel Sand)	1
	104807-04	Touch-up Paint Bottle with Brush (Porcelain Enamel Black)	1

** Included In Hardware Kit

SPECIFICATIONS

	SVYD18PRA	SVYD18NRA
Btu (Variable)	16,000/30,000	16,000/30,000
Type Gas	Propane/LP Only	Natural Only
Ignition	Piezo	Piezo
Pressure Manifold	8" W.C.	3.5" W.C.
Inlet Gas Pressure (in. of water)		
Maximum	14"	10.5"
Minimum*	11"	5"
Shipping Weight	28 lbs.	28 lbs.

* For input adjustment

WIRING DIAGRAM

Note: For proper operation of optional accessories, the wires from the switch to the control must be connected exactly as shown.

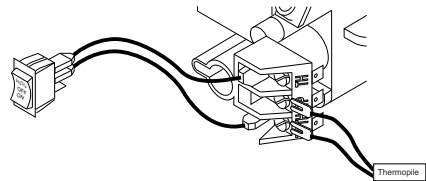

REPLACEMENT PARTS

Note: Use only original replacement parts. This will protect your warranty coverage for parts replaced under warranty.

PARTS UNDER WARRANTY

Contact authorized dealers of this product. If they can't supply original replacement part(s), call DESA Heating Products' Technical Service Department at 1-866-672-6040. When calling DESA Heating Products, have ready

- your name and address
- model and serial numbers of your heater
- how heater was malfunctioning
- type of gas used (propane/LP or natural gas)
- purchase date

Usually, we will ask you to return the part to the factory.

PARTS NOT UNDER WARRANTY

Contact authorized dealers of this product. If they can't supply original replacement part(s), call DESA Heating Products at 1-866-672-6040 for referral information. When calling DESA Heating Products, have ready

- model number of your heater
- the replacement part number

SERVICE HINTS

When Gas Pressure Is Too Low

- pilot will not stay lit
- burners will have delayed ignition
- heater will not produce specified heat
- propane/LP gas supply may be low (propane/LP only)

You may feel your gas pressure is too low. If so, contact your local propane/LP or natural gas supplier.

TECHNICAL SERVICE

You may have further questions about installation, operation, or troubleshooting. If so, contact DESA Heating Products' Technical Service Department at 1-866-672-6040. When calling, please have your model and serial numbers of your heater ready.

You can also visit DESA Heating Products' technical services web site at www.desatech.com.

ACCESSORIES

Purchase these heater accessories from your local dealer. If they can not supply these accessories, call DESA Heating Products at 1-866-672-6040 for referral information. You can also write to the address listed on the back page of this manual.

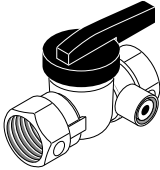

EQUIPMENT SHUTOFF VALVE GA5010

For all models. Equipment shutoff valve with 1/8" NPT tap. Fits 1/2" NPT pipe.

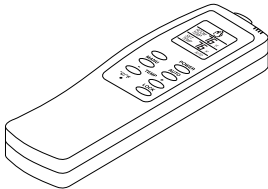

RECEIVER AND HAND-HELD THERMOSTAT REMOTE CONTROL KIT - GHRCTB

For remote-ready models. Allows the gas log heater to be operated in a manually or thermostatically controlled mode. You can turn the gas log heater on and off without ever leaving the comfort of your easy chair.

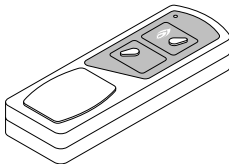

RECEIVER AND HAND-HELD REMOTE CONTROL KIT - GHRCB

For remote-ready models. Allows the gas log heater to be turned on and off by using a hand-held remote control.

WALL-MOUNT THERMOSTAT SWITCH GWMT1

(Not Shown)

For remote-ready models. The desired comfort setting can be selected on the wall thermostat and the log heater will automatically cycle from pilot to the heat setting selected.

WALL-MOUNT ON/OFF SWITCH - GWMS2

(Not Shown)

For remote-ready models. Allows the gas log heater to be turned on and off with a wall switch.

CLEANING KIT - GCK

(Not Shown)

For all models. Your vent-free gas appliance requires regular cleaning and maintenance to prevent performance problems. This kit gives you the tools and instructions to make it easy to clean all critical areas of your appliance.

INFORMATION VIDEO - 108917-01

For all models. A care and maintenance video is available by calling 1-866-672-6040. You may also email your request to

productsupport@desaint.com.

FIRE CRACKLE - CF6-A

(Not Shown)

For all models. Creates the sound of a real burning fire.

STOVE HEARTH BASE - GC10SP

(Not Shown)

For all models. Hearth base stained oak finish. Required when stove is placed on carpet. Dimensions 4" x 35 3/4" x 30 1/2" (H x W x D).

STOVE CONVERSION KIT - 113051-01

For models using SYVD18NR/PR vent-free stove inserts. This kit supplies stove back panel, stove dropped bottom and needed hardware to mount the vent-free heater into the stove.

WARRANTY INFORMATION

KEEP THIS WARRANTY

Model _____
Serial No. _____
Date Purchased _____

Always specify model and serial numbers when communicating with the factory.

We reserve the right to amend these specifications at any time without notice. The only warranty applicable is our standard written warranty. We make no other warranty, expressed or implied.

LIMITED WARRANTY

Vent-Free Gas Log Heaters and Oxford™ and Victor Hearth™ Stove Chassis

DESA Heating Products warrants this product to be free from defects in materials and components for four (4) years from the date of first purchase, provided that the product has been properly installed, operated and maintained in accordance with all applicable instructions. To make a claim under this warranty the Bill of Sale or cancelled check must be presented.

This warranty is extended only to the original retail purchaser. This warranty covers the cost of part(s) required to restore this heater to proper operating condition and an allowance for labor when provided by a DESA Heating Products Authorized Service Center. Warranty part(s) MUST be obtained through authorized dealers of this product and/or DESA Heating Products who will provide original factory replacement parts. Failure to use original factory replacement parts voids this warranty. The heater MUST be installed by a qualified installer in accordance with all local codes and instructions furnished with the unit.

This warranty does not apply to parts that are not in original condition because of normal wear and tear, or parts that fail or become damaged as a result of misuse, accidents, lack of proper maintenance or defects caused by improper installation. Travel, diagnostic cost, labor, transportation and any and all such other costs related to repairing a defective heater will be the responsibility of the owner.

TO THE FULL EXTENT ALLOWED BY THE LAW OF THE JURISDICTION THAT GOVERNS THE SALE OF THE PRODUCT; THIS EXPRESS WARRANTY EXCLUDES ANY AND ALL OTHER EXPRESSED WARRANTIES AND LIMITS THE DURATION OF ANY AND ALL IMPLIED WARRANTIES, INCLUDING WARRANTIES OF MERCHANTABILITY AND FITNESS FOR A PARTICULAR PURPOSE TO FOUR (4) YEARS ON ALL COMPONENTS FROM THE DATE OF FIRST PURCHASE; AND DESA HEATING PRODUCTS' LIABILITY IS HEREBY LIMITED TO THE PURCHASE PRICE OF THE PRODUCT AND DESA HEATING PRODUCTS SHALL NOT BE LIABLE FOR ANY OTHER DAMAGES WHATSOEVER INCLUDING INDIRECT, INCIDENTAL OR CONSEQUENTIAL DAMAGES.

Some states do not allow a limitation on how long an implied warranty lasts or an exclusion or limitation of incidental or consequential damages, so the above limitation on implied warranties, or exclusion or limitation on damages may not apply to you.

This warranty gives you specific legal rights, and you may also have other rights that vary from state to state.

For information about this warranty write:



2701 Industrial Drive
P.O. Box 90004
Bowling Green, KY 42102-9004
www.desatech.com



113084 01

NOT A UPC

113084-01

Rev. A

03/04